

Save Time! Save Money!

All 3000 Series Parts Numbers are Complete "Ready to Use" Assemblies.





Ref	Description	Model	Model	Model
		M8-S	M10-S	M12-S
		P/N	P/N	P/N
1	Cam Tube	4403	4404	4405
2-3	F-Bar w/SS / Tape Rule Contr	3950B	3952B	3954B
4	Front Hinge w/Red Vinyl Strip	3961	3962	3963
5-6	Rear Hinge Contr	4425	4427	4429
7-8	Base Rail Contr	4437	4439	4441
9	Strips, Red Vinyl Wear (2 ea)	3658	3658	3658
10	*Strip, Stainless Steel 60 Series	4771	4772	4773
10	*Strip, Stainless Steel Power Lock™	4792	4793	4794
11	Hinge Pin	4062	4063	4064
12	Tape Rule	4765	4765	4765

*Can ship via UPS in 2 pcs.

Parts For All Models

Ref	Part Name	P/N
13	Handle, Bending w/Brkts	3969
14	Brackets, Bending Handle (2 ea)	3579
15	Handle, Locking w/Brackets	3970
16	Brackets, Locking Handle (2 ea)	3931
17	Handles, Carrying (2 ea)	3968
18	Cam, Locking	4801
19	Pads, Wedge UHMW (6 ea)	3971
20	Bearings, Cam Tube UHMW (2 ea)	3901
21	Springs, Coil 3/4x1 3/4" (4 ea)	3902
22	Casting, Upper Pivot Arm	4462
23	Casting, Base C Clamp	4900
24-27	Material Stop Assembly (2 ea)	3965
28	Red Grip for Lock/Bend Handle	4464

Optional Accessories

TrimCutter™ 3017	Wheel Kit 3004	UniLeg™ UNL1	TrimFormer™ 3015
			
Cuts wide range of materials on all Mark Series brakes	Fits All Van Mark Brakes Attaches to one end of Brake Base Rails	Provides stable footing on many Van Mark tools	Add architectural depth to trim work

Tune-Up Kits

Contractor Model P/N 3966

Ref	Description
9	Strip, Red Vinyl Wear (2 ea)
19	Wedge Pads UHMW
21	Pivot Arm Spring
	Screws & Fasteners Package, Misc

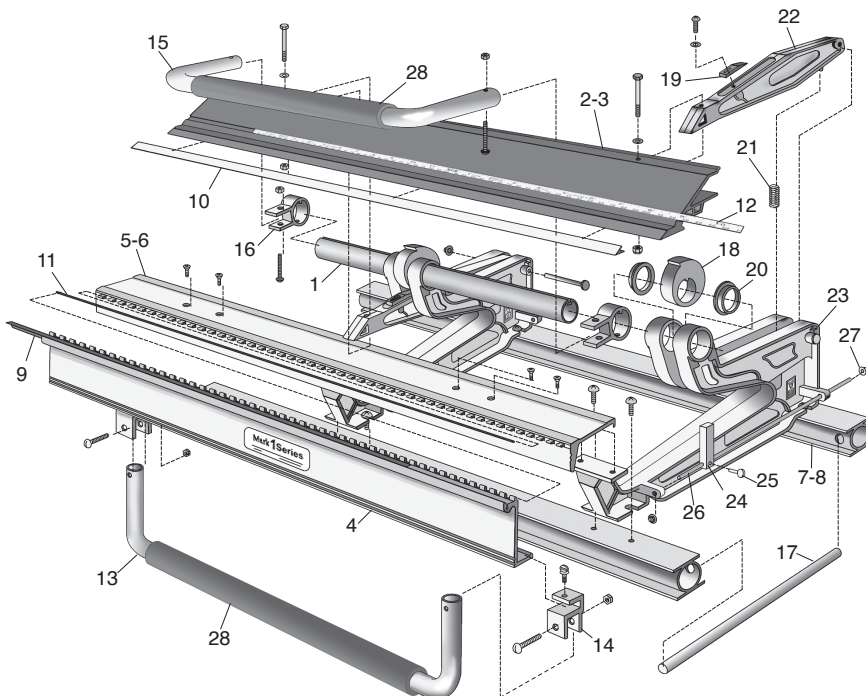

Ref no. 10

How to Identify Stainless Steel Edge

Stainless Steel Edge

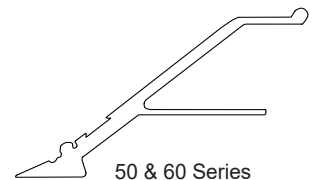
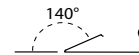

Stainless Steel Edge

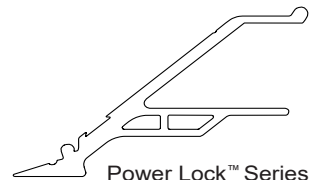
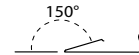

Mark I 60 Series

Orders must include model and serial no. in order to guarantee correct parts are shipped.

